

Top View

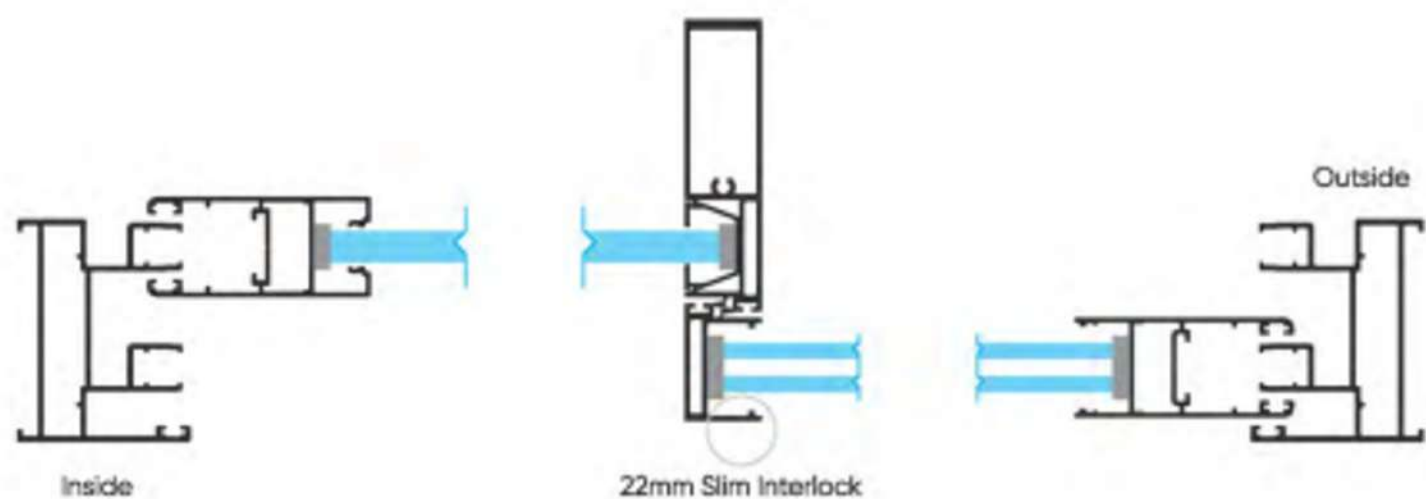

Side View

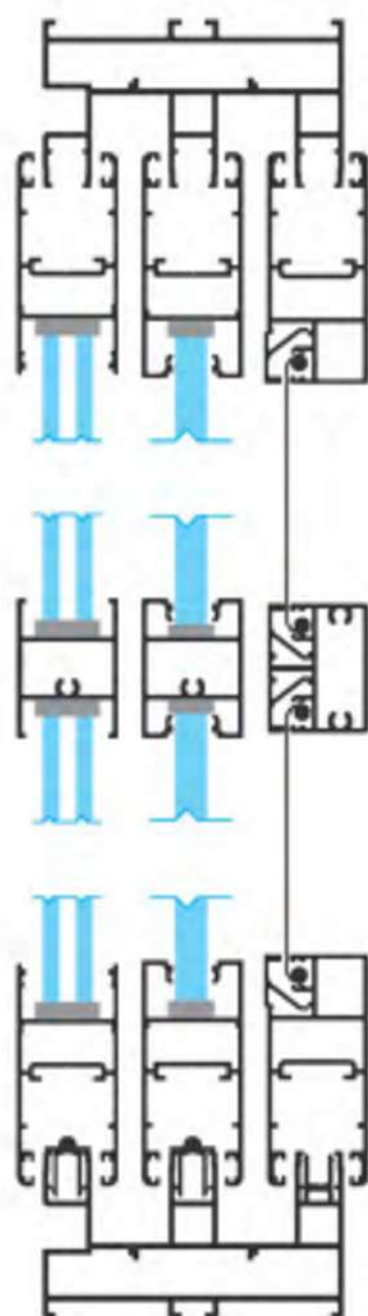

TWO TRACK

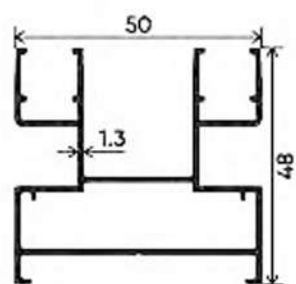

TWO TRACK

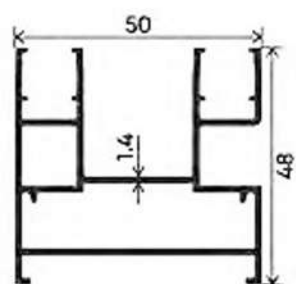

TWO TRACK

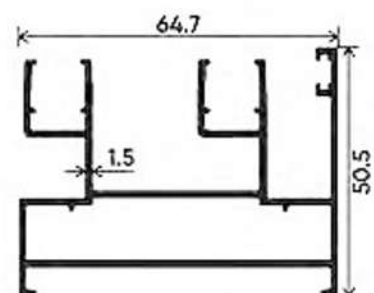

THREE TRACK

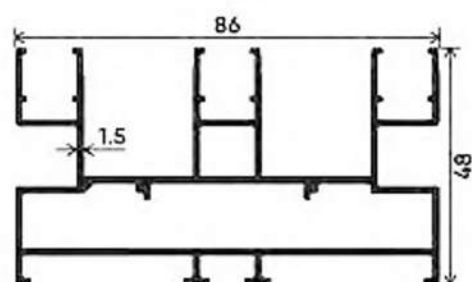

THREE TRACK

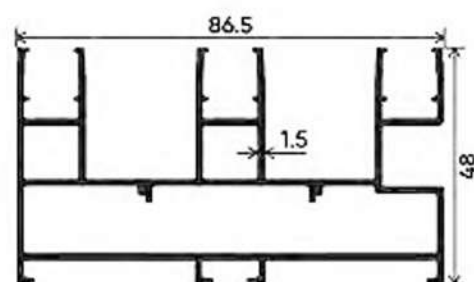

THREE TRACK

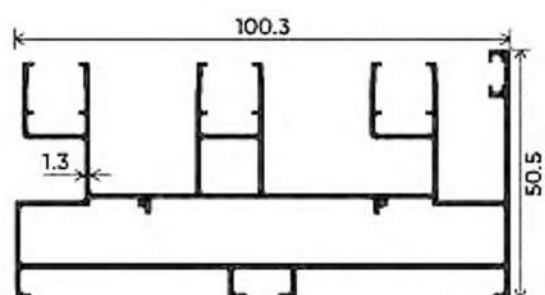

ADDITIONAL TRACK

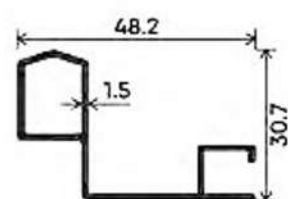

SHUTTER

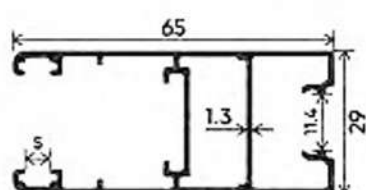

SHUTTER

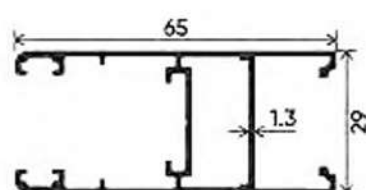

SHUTTER

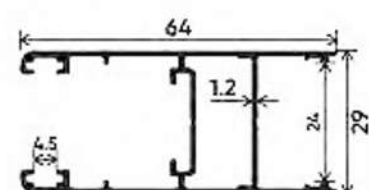

SHUTTER

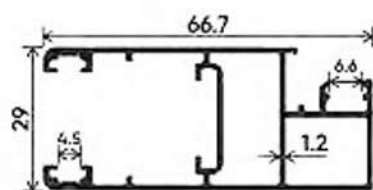

INTERLOCK CLIP

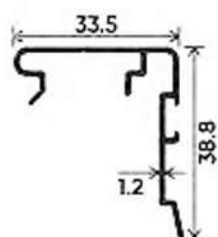

CLIP

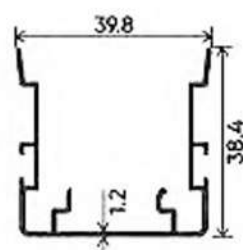

SHUTTER

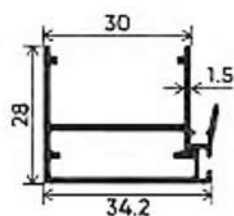

INTERLOCK

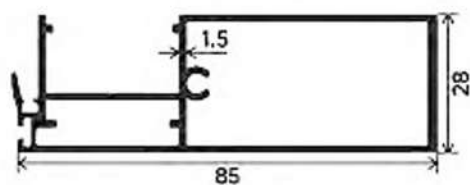

REDUCER CLIP

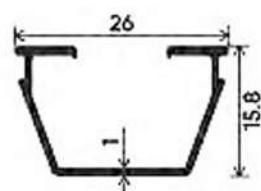

SHUTTER

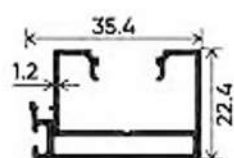

SHUTTER

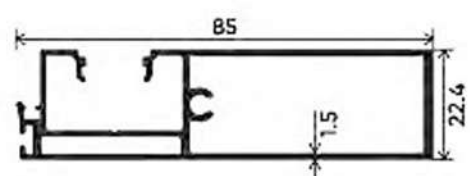

SHUTTER

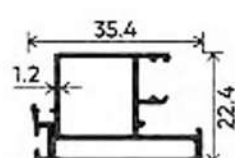

INTERLOCK

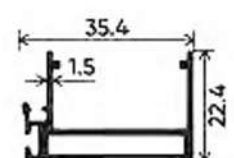

CLIP

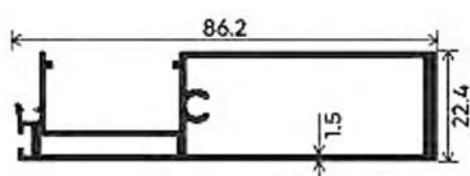

SHUTTER

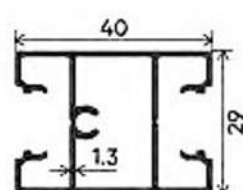

MIDDLE SHUTTER

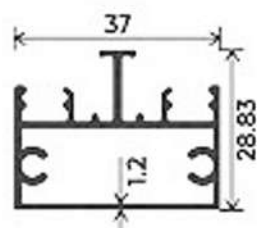

SHUTTER CLIP

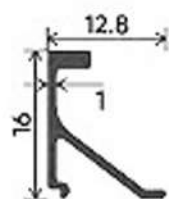

TRACK RAIL CLIP

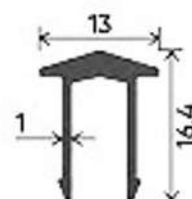

TRACK RAIL CLIP

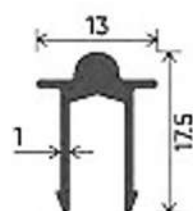

TRACK RAIL CAP

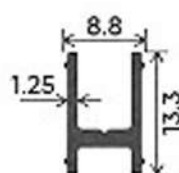

MOSQUITO CLIP

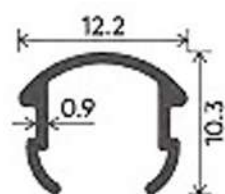

LOCKING ROD

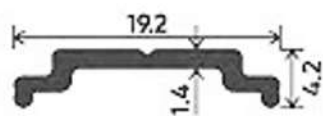

ANGLE

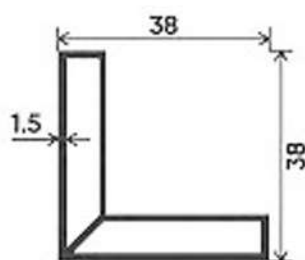

MEETING SECTION

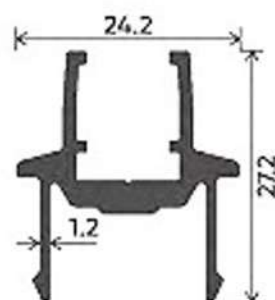

GEORGIAN BAR

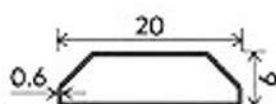

GEORGIAN BAR

